

Gallium Nitride 28V, 5W RF Power Transistor

Built using the SIGANTIC[®] NRF1 process - A proprietary GaN-on-Silicon technology

FEATURES

- Optimized for CW, pulsed, WiMAX, W-CDMA, LTE, and other applications from DC to 6GHz
- 100% RF Tested at 2500MHz
- 5W P3dB CW Power
- 15.5dB Power Gain
- Low cost, surface mount SOIC package
- High reliability gold metallization process
- Lead-free and RoHS compliant
- Subject to EAR99 Export Control



**DC - 6000MHz
5 Watt, 28 Volt
GaN HEMT**



2-Tone Specifications: $V_{DS} = 28V$, $I_{DQ} = 50mA$, Frequency = 2500MHz, Tone spacing = 1MHz, $T_C = 25^\circ C$
Measured in Nitronex Test Fixture

Symbol	Parameter	Min	Typ	Max	Units
$P_{1dB,PEP}$	Peak Envelope Power at 1dB Compression	5.0	7.5	-	W
G_{SS}	Small Signal Gain	14.5	15.5	-	dB
P_{IMD3}	Peak Envelope Power at -35dBc IMD3	-	2.5	-	W
η	Drain Efficiency at 3dB Compression	55	60	-	%

RF Performance (CW): $V_{DS} = 28V$, $I_{DQ} = 50mA$, Frequency = 2500MHz, $T_C = 25^\circ C$, Measured in Nitronex Test Fixture

Symbol	Parameter	Typ	Units
P_{3dB}	Average Output Power at 3dB Compression	5.1	W
P_{1dB}	Average Output Power at 1dB Compression	2.9	W
η	Drain Efficiency at 3dB Compression	56	%

OFDM Performance: $V_{DS} = 28V$, $I_{DQ} = 100mA$, Single carrier OFDM waveform 64-QAM 3/4, 8 burst, continuous frame data, 3.5 MHz channel bandwidth. Peak/Avg. = 10.3dB @ 0.01% probability on CCDF. Frequency = 3500MHz, $P_{OUT,AVG} = 24dBm$, $T_C = 25^\circ C$. Measured in Load Pull System

Symbol	Parameter	Typ	Units
G_p	Power Gain	11.2	dB
η	Drain Efficiency	9	%
EVM	Error Vector Magnitude	1.0	%

DC Specifications: $T_C=25^{\circ}\text{C}$

Symbol	Parameter	Min	Typ	Max	Units
Off Characteristics					
V_{BDS}	Drain-Source Breakdown Voltage ($V_{GS} = -8\text{V}$, $I_D = 2\text{mA}$)	100	-	-	V
I_{DLK}	Drain-Source Leakage Current ($V_{GS} = -8\text{V}$, $V_{DS} = 60\text{V}$)	-	0.5	2	mA
On Characteristics					
V_T	Gate Threshold Voltage ($V_{DS} = 28\text{V}$, $I_D = 2\text{mA}$)	-2.0	-1.5	-1.0	V
V_{GSQ}	Gate Quiescent Voltage ($V_{DS} = 28\text{V}$, $I_D = 50\text{mA}$)	-1.8	-1.3	-0.8	V
R_{ON}	On Resistance ($V_{GS} = 2\text{V}$, $I_D = 15\text{mA}$)	-	2.0	2.2	Ω
I_D	Drain Current ($V_{DS} = 7\text{V}$ pulsed, 300 μs pulse width, 0.2% duty cycle, $V_{GS} = 2\text{V}$)	1.1	1.3	-	A

Absolute Maximum Ratings: Not simultaneous, $T_C=25^{\circ}\text{C}$ unless otherwise noted

Symbol	Parameter	Max	Units
V_{DS}	Drain-Source Voltage	100	V
V_{GS}	Gate-Source Voltage	-10 to 3	V
P_T	Total Device Power Dissipation (Derated above 25°C)	7.6	W
θ_{JC}	Thermal Resistance (Junction-to-Case)	23	$^{\circ}\text{C}/\text{W}$
T_{STG}	Storage Temperature Range	-65 to 150	$^{\circ}\text{C}$
T_J	Operating Junction Temperature	200	$^{\circ}\text{C}$
HBM	Human Body Model ESD Rating (per JESD22-A114)	1A (>250V)	
MM	Machine Model ESD Rating (per JESD22-A115)	M1(>50V)	
MSL	Moisture Sensitivity Level (per IPC/JEDEC J-STD-020): Rating of 3 at 260°C Package Peak Temperature		

Load-Pull Data, Reference Plane at Device Leads

$V_{DS}=28V$, $T_A=25^{\circ}C$ unless otherwise noted

Table 1: Optimum Source and Load Impedances ($V_{DS} = 28V$)

Frequency	$Z_S (\Omega)$	$Z_L (\Omega)$	$I_{DQ} (mA)$	Optimized Tuning Condition
900	$9.2 + j23.8$	$52.6 + j22.8$	50	CW Power and Efficiency
1800	$5.2 + j0.5$	$24.5 + j18.3$	50	CW Power and Efficiency
2140	$5.0 - j2.6$	$17.1 + j15.0$	50	CW Power and Efficiency
2500	$5.4 - j10.5$	$14.7 + j10.0$	50	CW Power and Efficiency
3500	$5.0 - j21.0$	$11.2 + j4.7$	50	CW Power and Efficiency
900	$21.9 + j43.4$	$59.5 + j33.7$	100	W-CDMA, P_{OUT} , Efficiency, -45dBc ACPR
1800	$13.1 + j24.3$	$34.5 + j48.8$	100	W-CDMA, P_{OUT} , Efficiency, -45dBc ACPR
2140	$5.4 + j17.3$	$25.4 + j36.4$	100	W-CDMA, P_{OUT} , Efficiency, -45dBc ACPR
2600	$4.0 + j6.8$	$12.2 + j25.8$	100	LTE, P_{OUT} , Efficiency, -45dBc ACPR
2500	$5.0 + j16.2$	$13.2 + j20.4$	100	OFDM, Maximum P_{OUT} , 1.5% EVM
3500	$4.1 - j0.6$	$6.6 + j10.5$	100	OFDM, Maximum P_{OUT} , 1.5% EVM
5100	$17.8 - j16.4$	$10.7 - j4.9$	100	OFDM, Maximum P_{OUT} , 1.5% EVM
5200	$21.5 - j29.0$	$11.9 - j4.8$	100	OFDM, Maximum P_{OUT} , 1.5% EVM
5700	$10.2 - j13.2$	$11.3 - j17.0$	100	OFDM, Maximum P_{OUT} , 1.5% EVM
5800	$11.0 - j16.3$	$12.1 - j15.3$	100	OFDM, Maximum P_{OUT} , 1.5% EVM

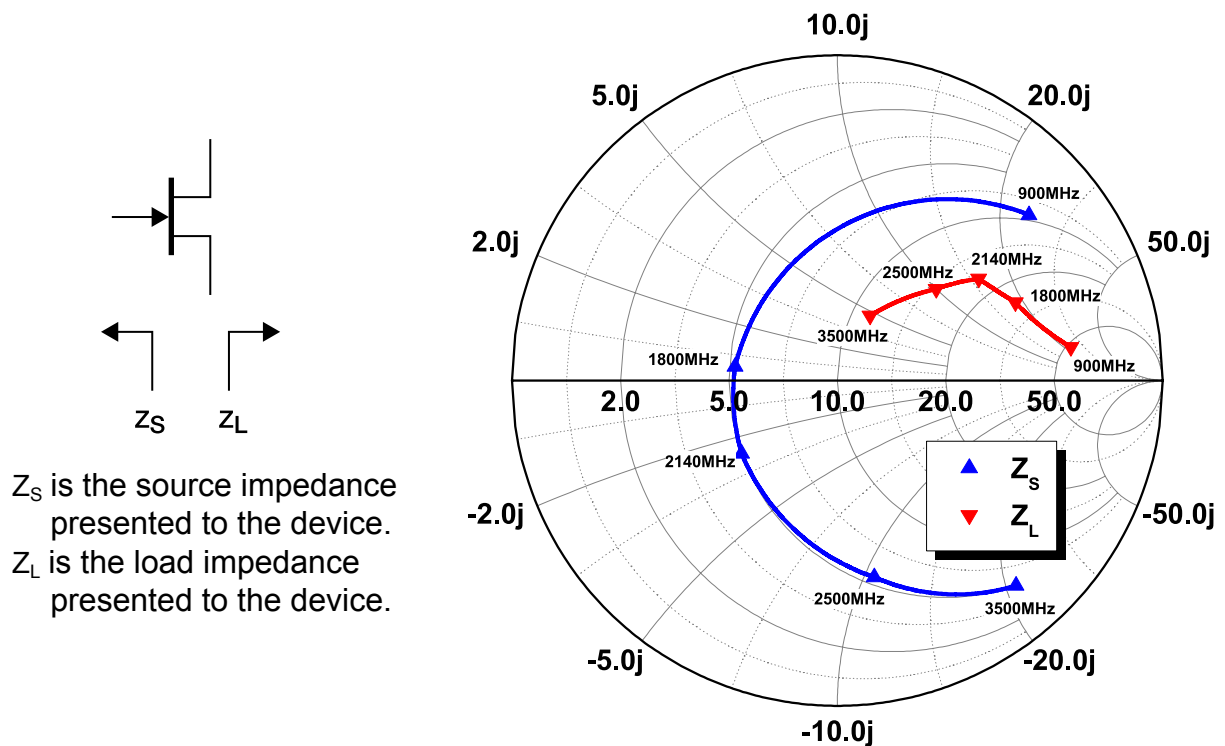

Figure 1 - Impedances for Optimum CW Power, $V_{DS} = 28V$, $I_{DQ} = 50mA$

Load-Pull Data, Reference Plane at Device Leads

$V_{DS}=28V, I_{DQ}=50mA, T_A=25^{\circ}C$ unless otherwise noted.

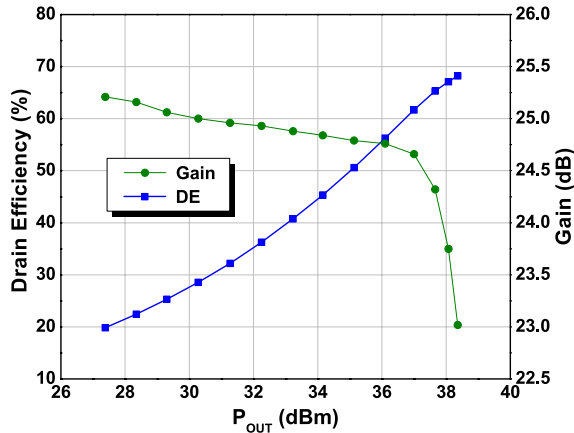

Figure 2 - Typical CW Performance
Frequency = 900MHz

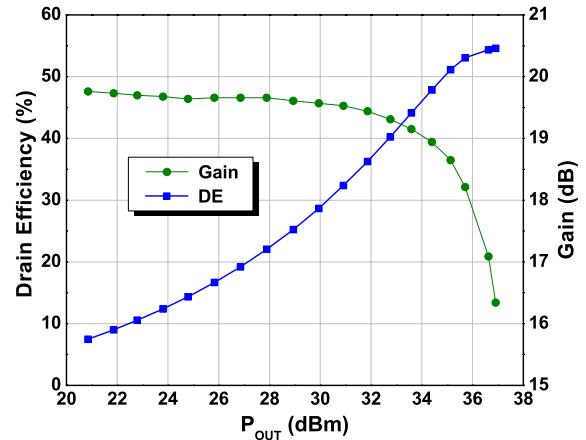

Figure 3 - Typical CW Performance
Frequency = 2500MHz

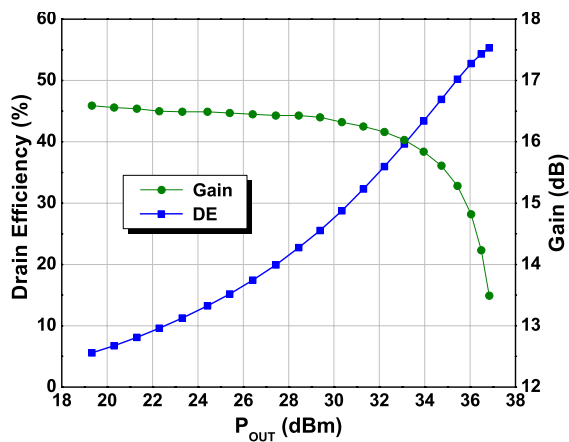

Figure 4 - Typical CW Performance
Frequency = 3500MHz

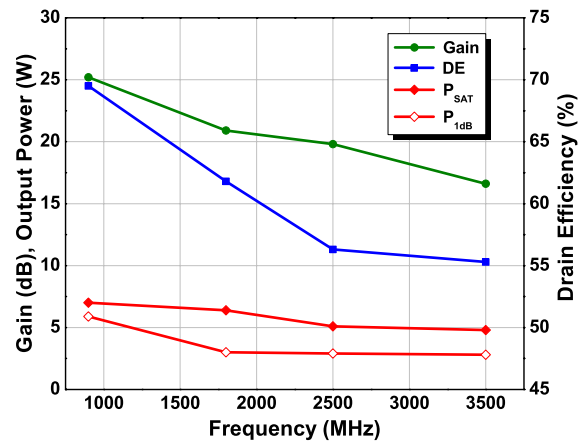

Figure 5 - Typical CW Performance
Frequency = 900 to 3500MHz

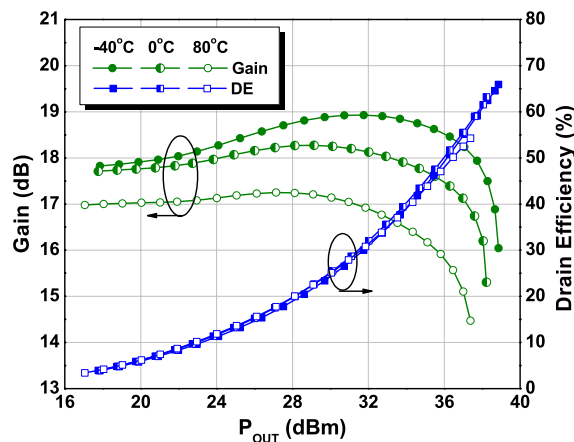

Figure 6 - Typical CW Performance
Over Temperature, Frequency = 2500MHz

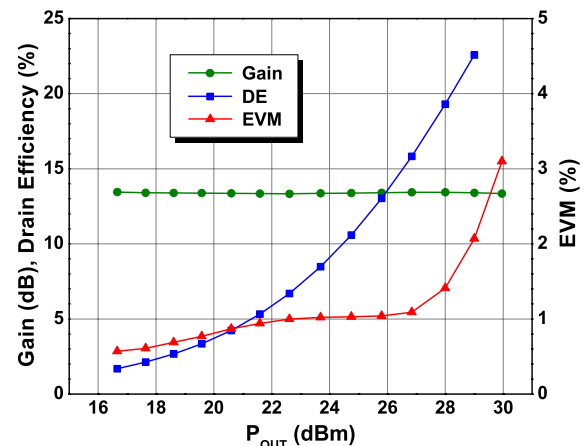

Figure 7 - Typical OFDM Performance
 $I_{DQ} = 100mA$, Frequency = 2500MHz

Load-Pull Data, Reference Plane at Device Leads

$V_{DS}=28V$, $I_{DQ}=50mA$, $T_A=25^{\circ}C$ unless otherwise noted.

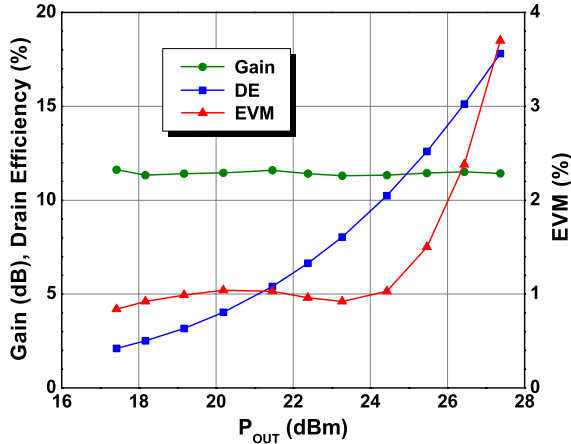

Figure 8 - Typical OFDM Performance
 $I_{DQ} = 100mA$, Frequency = 3500MHz

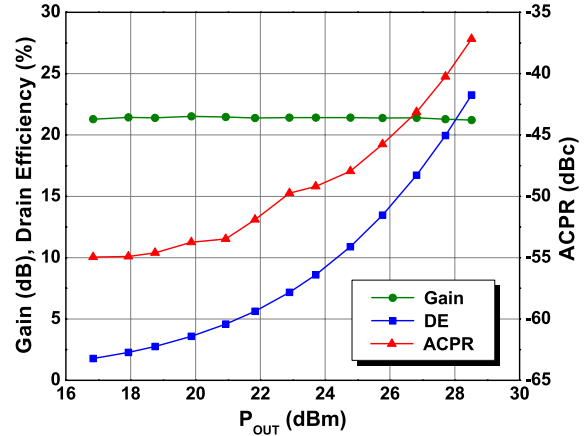

Figure 9 - Typical W-CDMA Performance
 $I_{DQ} = 100mA$, Frequency = 900MHz

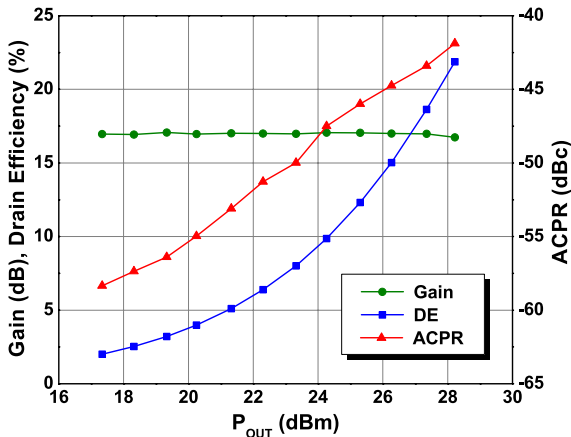

Figure 10 - Typical W-CDMA Performance
 $I_{DQ} = 100mA$, Frequency = 1800MHz

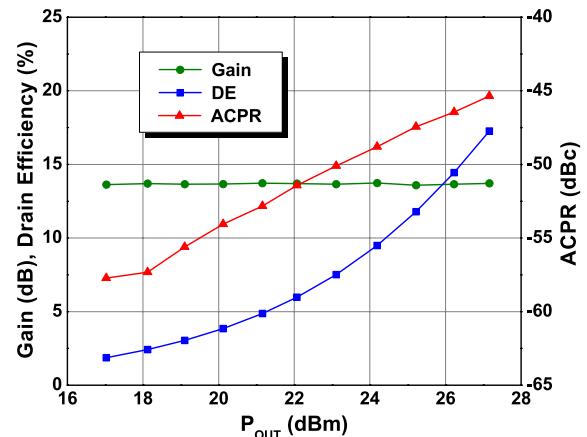

Figure 11 - Typical W-CDMA Performance
 $I_{DQ} = 100mA$, Frequency = 2140MHz

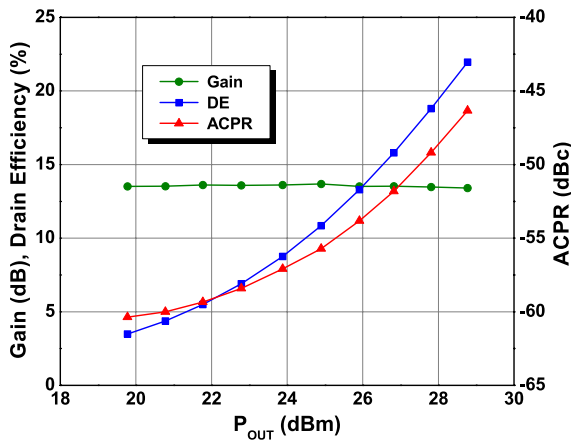

Figure 12 - Typical LTE Performance
 $I_{DQ} = 100mA$, Frequency = 2600MHz

Typical Device Characteristics

$V_{DS}=28V$, $I_{DQ}=50mA$, $T_A=25^\circ C$ unless otherwise noted.

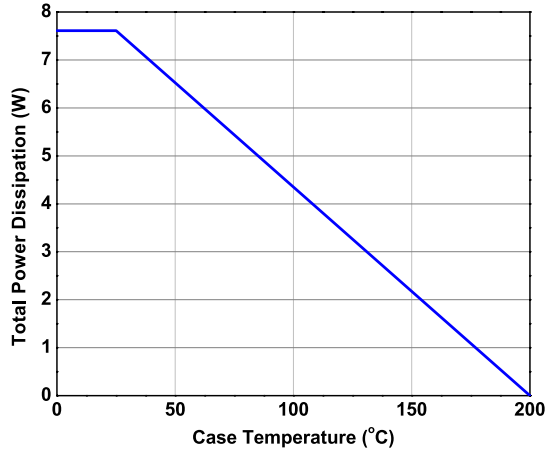

Figure 13 - Power Derating Curve

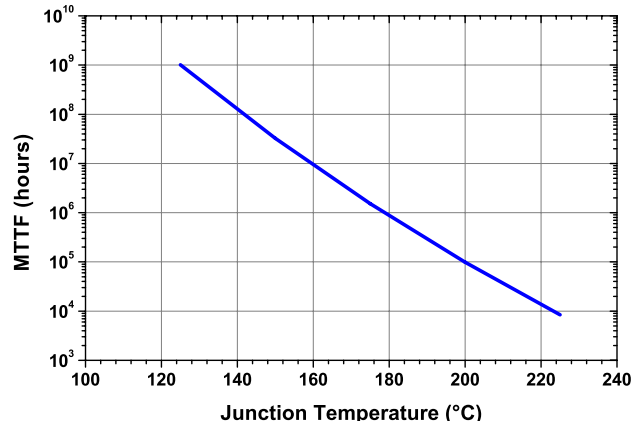

Figure 14 - MTTF of NRF1 Devices as a Function of Junction Temperature

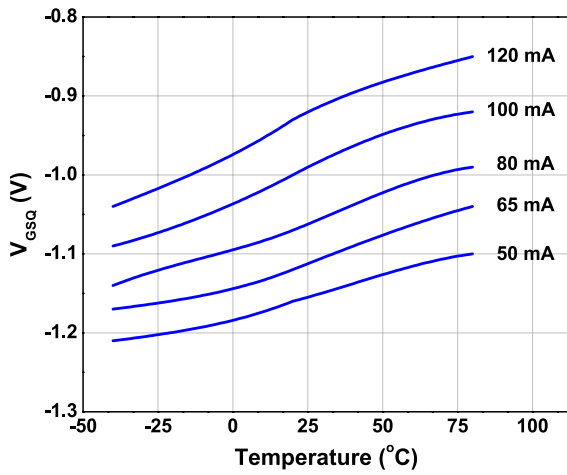

Figure 15 - Quiescent Gate Voltage (V_{GSQ}) Required to Reach $I_{DQ} = 50mA$ as a Function of Ambient Temperature

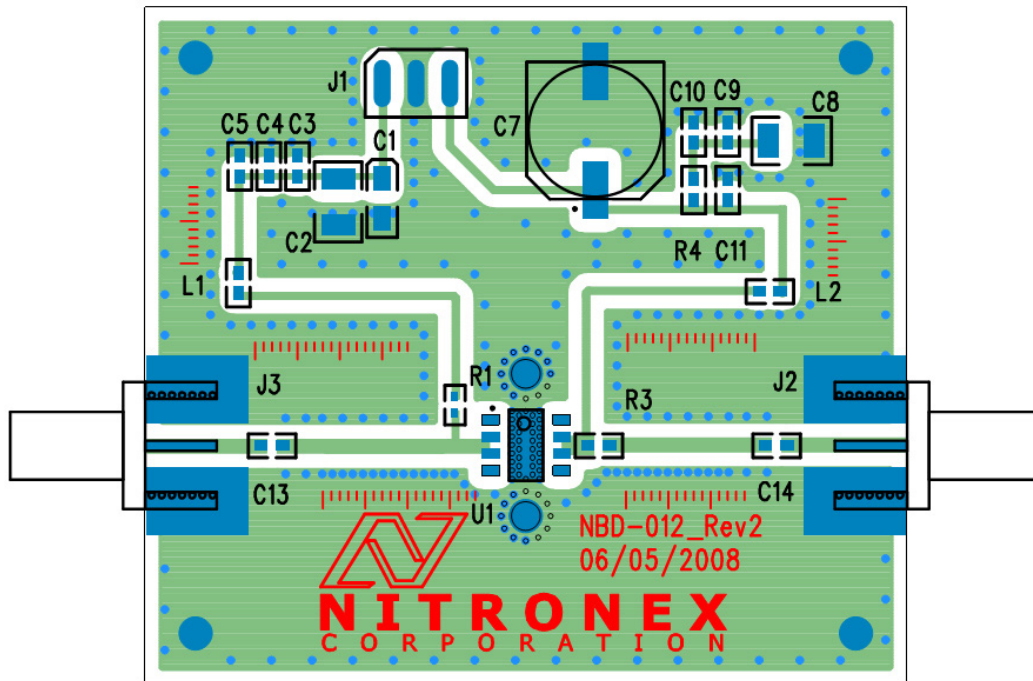

Figure 16 - APP-NPTB00004-25 2500MHz Demonstration Board

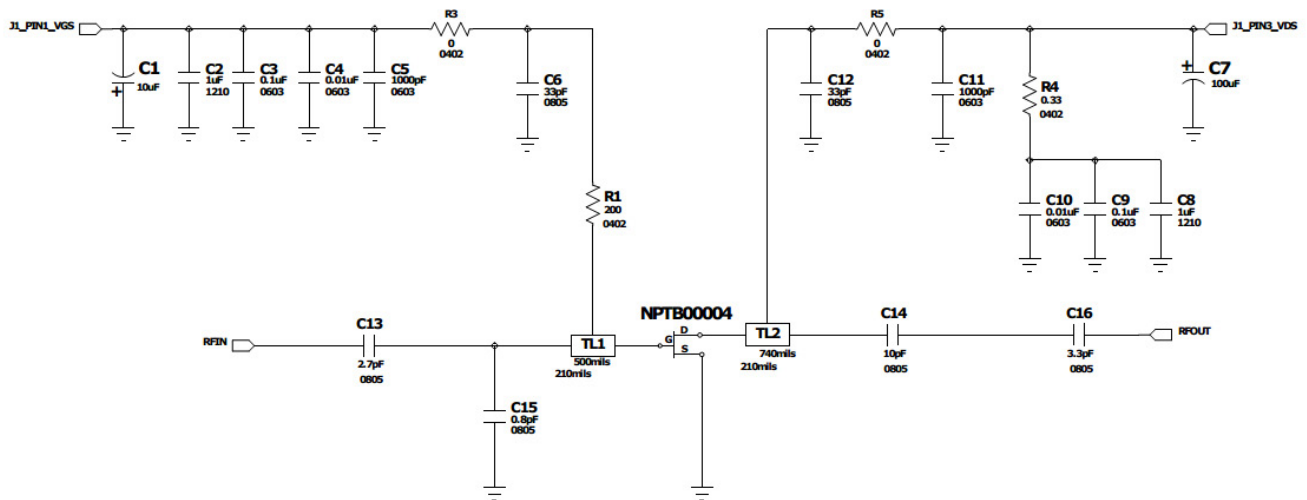

Figure 17 - APP-NPTB00004-25 2500MHz Demonstration Board Equivalent Circuit

Table 2: APP-NPTB00004-25 2500MHz Demonstration Board Bill of Materials

Name	Value	Tolerance	Vendor	Vendor Number
C1	10uF	20%	AVX	TAJA106M016R
C2	1uF	10%	AVX	12101C105KAT2A
C3	0.1uF	10%	Murata	GRM188R72A104KA35D
C4	0.01uF	10%	AVX	06031C103KAT2A
C5	0.001uF	10%	AVX	06031C102KAT2A
C6	33pF	5%	ATC	ATC600F330B
C7	100uF	20%	Panasonic	ECE-V1JA101P
C8	1uF	10%	AVX	12101C105KAT2A
C9	0.1uF	10%	Murata	GRM188R72A104KA35D
C10	0.01uF	10%	AVX	06031C103KAT2A
C11	0.001uF	10%	AVX	06031C102KAT2A
C12	33pF	5%	ATC	ATC600F330B
C13	2.7pF	+/- 0.1pF	ATC	ATC600F2R7B
C14	10pF	1%	ATC	ATC600F100B
C15	0.8pF	+/-0.1pF	ATC	ATC600F0R8B
C16	3.3pF	+/-0.1pF	ATC	ATC600F3R3B
R1	200 ohm	1%	Panasonic	ERJ-2GEJ201X
R3, R5	0 ohm	--	Panasonic	ERJ-2GE0R00X
R4	0.033 ohm	1%	Panasonic	ERJ-6BWJR033W
NBD-012_Rev1	--	--	Alberta Printed Circuits	NBD-012_Rev1
Substrate			Rogers	R04350, t = 30mil $\epsilon_r = 3.5$

Ordering Information¹

Part Number	Order Multiple	Description
NPTB00004DT	97	Tube; NPTB00004 in D (PSOP2) Package
NPTB00004DR	1500	Tape and Reel; NPTB00004 in D (PSOP2) Package

1: To find a Nitronex contact in your area, visit our website at <http://www.nitronex.com>

D Package Dimensions and Pinout

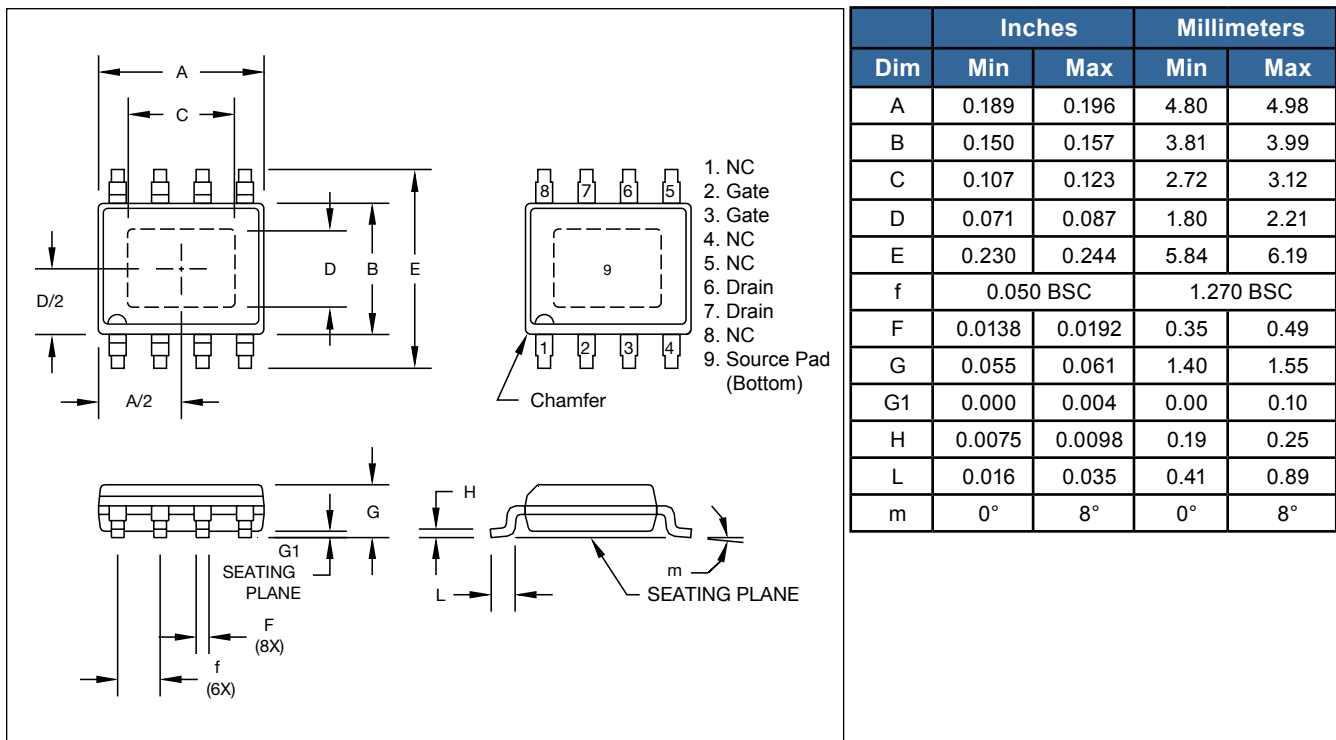

Mounting Footprints

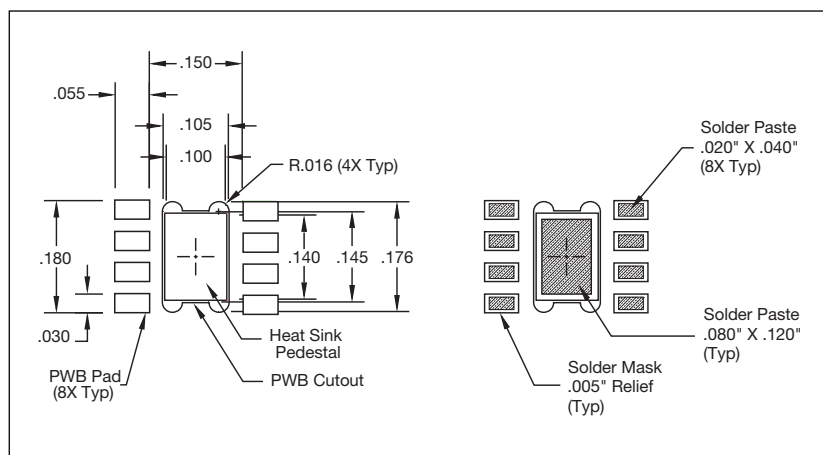

Nitronex, LLC

2305 Presidential Drive
Durham, NC 27703 USA
+1.919.807.9100 (telephone)
+1.919.807.9200 (fax)
info@nitronex.com
www.nitronex.com

Additional Information

This part is lead-free and is compliant with the RoHS directive (Restrictions on the Use of Certain Hazardous Substances in Electrical and Electronic Equipment).

Important Notice

Nitronex, LLC reserves the right to make corrections, modifications, enhancements, improvements and other changes to its products and services at any time and to discontinue any product or service without notice. Customers should obtain the latest relevant information before placing orders and should verify that such information is current and complete. All products are sold subject to Nitronex terms and conditions of sale supplied at the time of order acknowledgment. The latest information from Nitronex can be found either by calling Nitronex at 1-919-807-9100 or visiting our website at www.nitronex.com.

Nitronex warrants performance of its packaged semiconductor or die to the specifications applicable at the time of sale in accordance with Nitronex standard warranty. Testing and other quality control techniques are used to the extent Nitronex deems necessary to support the warranty. Except where mandated by government requirements, testing of all parameters of each product is not necessarily performed.

Nitronex assumes no liability for applications assistance or customer product design. Customers are responsible for their product and applications using Nitronex semiconductor products or services. To minimize the risks associated with customer products and applications, customers should provide adequate design and operating safeguards.

Nitronex does not warrant or represent that any license, either express or implied, is granted under any Nitronex patent right, copyright, mask work right, or other Nitronex intellectual property right relating to any combination, machine or process in which Nitronex products or services are used.

Reproduction of information in Nitronex data sheets is permitted if and only if said reproduction does not alter any of the information and is accompanied by all associated warranties, conditions, limitations and notices. Any alteration of the contained information invalidates all warranties and Nitronex is not responsible or liable for any such statements.

Nitronex products are not intended or authorized for use in life support systems, including but not limited to surgical implants into the body or any other application intended to support or sustain life. Should Buyer purchase or use Nitronex, LLC products for any such unintended or unauthorized application, Buyer shall indemnify and hold Nitronex, LLC, its officers, employees, subsidiaries, affiliates, distributors, and its successors harmless against all claims, costs, damages, and expenses, and reasonable attorney fees arising out of, directly or indirectly, any claim of personal injury or death associated with such unintended or unauthorized use, notwithstanding if such claim alleges that Nitronex was negligent regarding the design or manufacture of said products.

Nitronex and the Nitronex logo are registered trademarks of Nitronex, LLC.
All other product or service names are the property of their respective owners.
©Nitronex, LLC 2012. All rights reserved.